

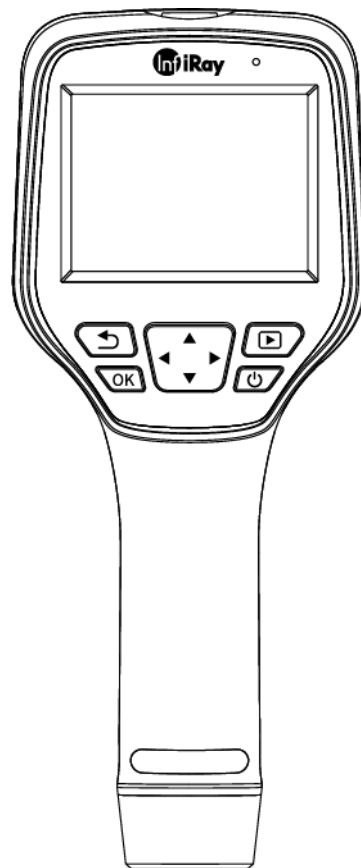

# **Tianxuan M305&M600**

## **Handheld Thermal Camera**

### **User Manual V1.1.0**



**IRay Technology Co., Ltd.**

[www.infiray.com](http://www.infiray.com)

# Explore And Perceive The Future

## Introduction to IRay Technology

IRay Technology Co., Ltd. concentrates on developing infrared thermal imaging technologies and manufacturing relevant products, with completely independent intellectual property rights. IRay is committed to providing global customers with professional and competitive infrared thermal imaging products and solutions. The main products include IRFPA detectors, thermal imaging modules, and terminal thermal imaging products.

With R&D personnel accounts for 48% of all employees, 787 intellectual property projects in terms of IRay have been authorized and accepted: 629 patented technologies authorized and accepted in China (including those for integrated circuit chips, MEMS sensors design and manufacture, Matrix III image algorithms and intelligent precise temperature measurement algorithms, etc.); 18 patented technologies authorized and accepted overseas; 101 software copyrights; and 39 integrated circuit layout designs.

(The statistic data is up to August,2021 )

IRay products have been applied in various fields, including epidemic prevention and control, industrial thermography, security and fire control, night vision observation, automatic driving, Internet of Things, AI, and machine vision.

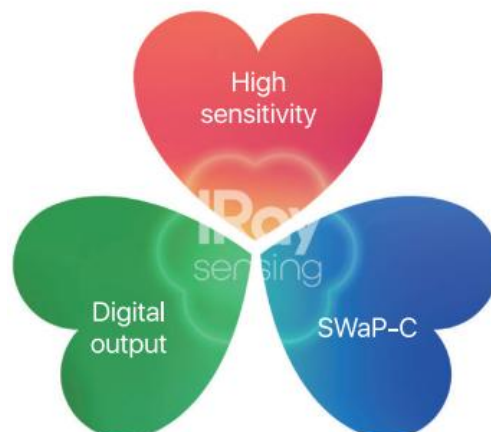

## Table of Contents

1. Legal Disclaimer .....	1
1.1 Legal Disclaimer .....	1
1.2 Copyright .....	1
1.3 Quality Assurance .....	1
2. Safety Information .....	2
3. Notice to user .....	4
3.1 Calibration .....	4
3.2 Accuracy .....	4
3.3 Video Teaching .....	4
3.4 Documentation Updates .....	4
3.5 Scope of Application .....	4
4. Customer Help .....	4
4.1 FAQ .....	4
4.2 Download .....	4
5. Comparison of Functions for Different Models .....	5
6. Product Introduction .....	6
6.1 Camera (View from the front) .....	6
6.2 Buttons (View from the rear) .....	7
6.3 Connector and Memory Card .....	8
7. Quick Start Guide .....	9
8. User Interface .....	10
9. Operation Instruction .....	11
9.1 Charging .....	11
9.1.1 Charge with a Power Adapter .....	11
9.1.2 Charge with a Computer .....	11
9.1.3 Charge with a Charging Base .....	11
9.2 Power On/Off .....	11
9.3 Focus Adjustment .....	12
Figure 9.1 Focus Adjustment Through Focus Ring .....	12
9.4 Images/Videos Capture .....	12
9.5 View Photos/Videos .....	13
9.6 Measurement Mode .....	14
9.7 Measurement Parameters .....	15
9.8 Palettes .....	17
9.9 Image Mode .....	18

---

9.9.1 Image Mode Introduction .....	18
9.9.2 Setting Steps .....	20
9.10 Non-uniformity Correction .....	20
9.10.1 Non-uniformity Correction Introduction .....	20
9.10.2 Non-uniformity Correction Operations .....	20
9.11 Contrast Adjustment .....	21
9.12 Digital Zoom .....	21
9.13 Other Settings .....	23
9.13.1 Temperature Measurement Mode .....	23
9.13.2 Above/Below Alarm .....	24
9.13.3 Wi-Fi Settings .....	25
9.13.4 Photo Settings .....	25
9.13.5 Dual-spectrum Alignment .....	26
9.13.6 Automatic Power-off .....	27
9.13.7 System Settings .....	27
10.Introduction of Application Scenarios .....	29
10.1 Detecting of Power Distribution Cabinet .....	29
10.2 Liquid Level Detecting of the Storage Tank .....	30
10.3 Circuit Board R&D .....	30
10.4 Defect Detecting of Refractory Material in Rotary Kiln .....	31
11.Structural Drawings .....	32
11.1 M305 .....	32
11.2 M600 .....	33
12.FAQ .....	34
13. Download Software and Update Firmware .....	34
13.1 Download Software .....	34
13.2 Update Firmware .....	34
14.Cleaning Thermal Camera .....	35
14.1 Cleaning Camera Housing, Cables and Other Items .....	35
14.2 Cleaning Infrared Lens .....	36

# 1. Legal Disclaimer

## 1.1 Legal Disclaimer

The thermal cameras manufactured by IRAY TECHNOLOGY are warranted for a period of two-year and the accessories are warranted for a period of three-month from the delivery date of the original purchase, provided such products have been under normal storage, use and maintenance.

This warranty extends only to the original purchaser and is not transferable. It is not applicable to any product which has been subjected to misuse, neglect, accident or abnormal conditions of operation.

In the case of a defect in a product covered by this warranty the product must not be further used or maintained in order to prevent additional damage. The purchaser shall promptly report any defect to IRAY TECHNOLOGY or this warranty will not apply.

IRAY TECHNOLOGY will, at its option, repair or replace any such defective product free of charge if, upon inspection, the product or accessories prove to be defective, the user can contact with after-sales service department of IRAY TECHNOLOGY within the said warranty period.

## 1.2 Copyright

©IRay Technology Co., Ltd. 2020. All rights reserved worldwide. All contents in this manual, including words, pictures, images, etc., belong to IRAY TECHNOLOGY CO., LTD. (Hereinafter referred to as "THE COMPANY" or "IRAY TECHNOLOGY"). No part of the manual, in whole or part, may be copied, photocopied, translated, or transmitted without the prior written permission of IRAY TECHNOLOGY.

This manual is used as a guide. The photos, graphics, diagrams and illustrations provided in the manual are only used to explain, which may be different from the specific product. The real product shall prevail. We try our best to make sure the contents in this manual are accurate. We do not provide any representations or warranties in this manual.

IRAY TECHNOLOGY reserve the right to update the manual. If you need the latest version of this manual, please contact us. It is recommended that you use this manual with the guidance of professionals.

## 1.3 Quality Assurance

The Quality Management System under which these products are developed and manufactured has been certified in accordance with the ISO9001 standard.

We reserve the right to make changes and improvements on any of the products without prior notice.

## 2.Safety Information

 **WARNING**

1. Make sure you read all applicable Material Safety Data Sheets (SDS) and warning labels on containers before you use a liquid. The liquids can be dangerous. Injury to persons can occur.
2. It is prohibited to use the product in a high temperature above 85 °C or in a low temperature below -45 °C.
3. It is forbidden to disassemble or refit the thermal camera at will.
4. Please charge the thermal camera at about 25° C.

 **WARNING**

**Applicability:** Class A digital devices.

This equipment has been tested and found to comply with the limits for a Class A digital device, pursuant to part 15 of the FCC Rules. These limits are designed to provide reasonable protection against harmful interference when the equipment is operated in a commercial environment. This equipment generates, uses, and can radiate radio frequency energy and, if not installed and used in accordance with the instruction manual, may cause harmful interference to radio communications. Operation of this equipment in a residential area is likely to cause harmful interference in which case the user will be required to correct the interference at his own expense.

 **WARNING**

**Applicability:** Digital devices subject to 15.19.

**NOTICE:** This device complies with Part 15 of the FCC Rules. Operation is subject to the following two conditions:

1. this device may not cause harmful interference, and
2. this device must accept any interference received, including interference that may cause undesired operation.

 **WARNING**

**Applicability:** Digital devices subject to 15.21.

**NOTICE:** Changes or modifications made to this equipment not expressly approved by InfiRay may void the FCC authorization to operate this equipment.

**CAUTION**

1. No matter there is a lens cover or not, do not point the infrared thermal camera towards strong light or equipment with laser radiation. This will affect the accuracy of the thermal camera and even damage the detector in the thermal camera.
2. Do not use the product under conditions that doesn't match the environmental requirements. For specific use environment requirements, see the product parameter table.
3. Do not apply solvents or equivalent liquids to the camera, the cables, or other items.
4. Be careful when you clean the infrared lenses. The lens has an anti-reflective coating which is easily damaged. Damage to the infrared lens can occur with too much force or cleaning with rough objects such as tissues.

## **3. Notice to user**

### **3.1 Calibration**

IRAY TECHNOLOGY recommends that you verify your calibration yearly in order to ensure accuracy. You can verify the calibration through IRAY TECHNOLOGY or third-party organizations.

### **3.2 Accuracy**

For very accurate results, we recommended that you wait 5 minutes after you have started the camera before measuring a temperature.

### **3.3 Video Teaching**

You can search for mount and use videos from our website.

### **3.4 Documentation Updates**

Our manuals are updated several times per year, and we also issue product-critical notifications of changes on a regular basis. Please visit our website to access the latest manuals and notifications.

### **3.5 Scope of Application**

This manual is applicable for all products in a range, which means that parts of the manual may not apply to a particular model.

## **4. Customer Help**

### **4.1 FAQ**

You can find answers to FAQ about this model on the service support page of our official website.

### **4.2 Download**

You can download the following contents from our website: [www.infiray.com](http://www.infiray.com)

- Product Documentation
- Client Software
- Video Teaching Courses



## 5.Comparison of Functions for Different Models

Function	M305	M600
IR Resolution	384×288	640×512
Visual Resolution	5MP	5MP
Display	3.5-inch (480×640)	3.5-inch (480×640)
NETD	40mK	40mK
Temperature Measurement Range	-20℃ ~ +550℃	-20℃ ~ +550℃
FOV	43.7°×31.9°	48°×38°
Focus Mode	Manual focus	Manual focus
Time-lapse Snapshot	yes	yes
Temperature Alarm	screen tip	screen tip
Alarm Snapshot	yes	yes
Temperature Measurement Mode	10 spots/10 lines/10 regions	10 spots/10 lines/10 regions
USB connection	U disk, UVC, support real-time temperature measurement analysis	U disk, UVC, support real-time temperature measurement analysis
Wireless	Hot spot (App)	Hot spot (App)
Battery Life	4h	3h

## 6. Product Introduction

### 6.1 Camera (View from the front)

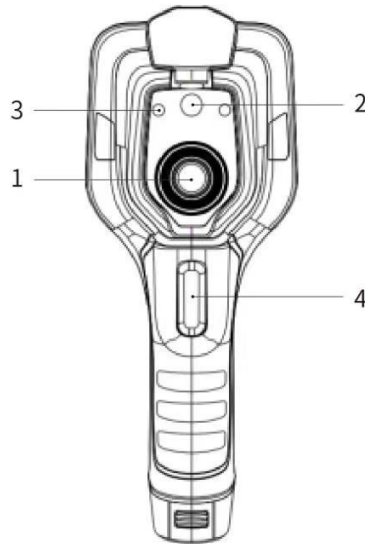

No.	Components
1	Infrared Lens
2	Digital Camera
3	Laser Pointer
4	Trigger

Table 6.1 Introduction to Camera Components (View from the Front)

Note: the laser warning label is stuck on the lens cap.



## 6.2 Buttons (View from the rear)

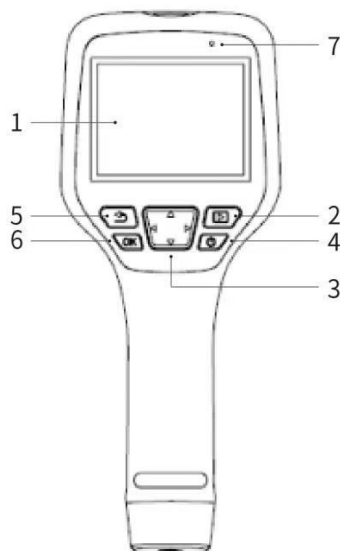

No.	Components	Function Description
1	Display screen	
2	Gallery button	Press to open the gallery. Long press to perform image uniformity correction.
3	Navigation button	Make selections for the menu, settings, gallery by clicking up/down/left/right.
4	Power/Laser button	Long press to turn on/off. When it is on, click to turn on/off the laser pointer.
5	Back button	Click to cancel the operation or return to the previous one. Long press to perform image uniformity correction.
6	Enter button	Click OK to confirm the operation.
7	Microphone	It's used to record voice notes after shooting.

**Table 6.2 Component Introduction (View from the Rear)**

### 6.3 Connector and Memory Card

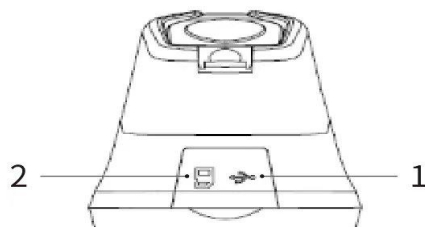

Figure6.3 Illustration of Connector and Memory Card

No.	Name	Description
1	USB Interface	Connect a USB cable with the power adapter for charging. Connect a USB cable to a computer to charge or transfer data.
2	SD Card	Standard MicroSD card, standard 32GB, it can save 140,000 images at most (exfat format) and can be extended to 512GB; The SD card can be taken out and transfer data to PC or other devices with a card reader.

Table 6.3 Connector and Memory Card

## 7.Quick Start Guide

### Please follow the procedures:

#### 1.Charging

- (1) 5V 3A power adapter and USB cable can be used to charge the device.
- (2) You can charge the device by connecting the USB cable in the accessory to the computer.

Note: This method of charging takes longer time than using the power adapter.

- (3) Charging base can also be used to charge the battery.

#### 2.Power on

Long press the power button to start the device.

#### 3.Target Searching

Point the thermal camera at the object of interest.

#### 4.Image Capturing

Click the trigger button to capture the image, and record the video by long pressing the trigger button.

#### 5.Analysis by PC Software

Run the client software after download, and then import data via an USB cable or SD card for further analysis.

Note: Please import the files of the same name with suffixes of jpg and irg together with the data. The file with the suffix irg contains data related to temperature. If lost, normal analysis cannot be carried out.

#### 6.Analysis by APP

Download and install the App on the mobile device. Enable hotspot on the thermal camera to which the mobile device is connected, run the App and import the data for further analysis.

## 8.User Interface

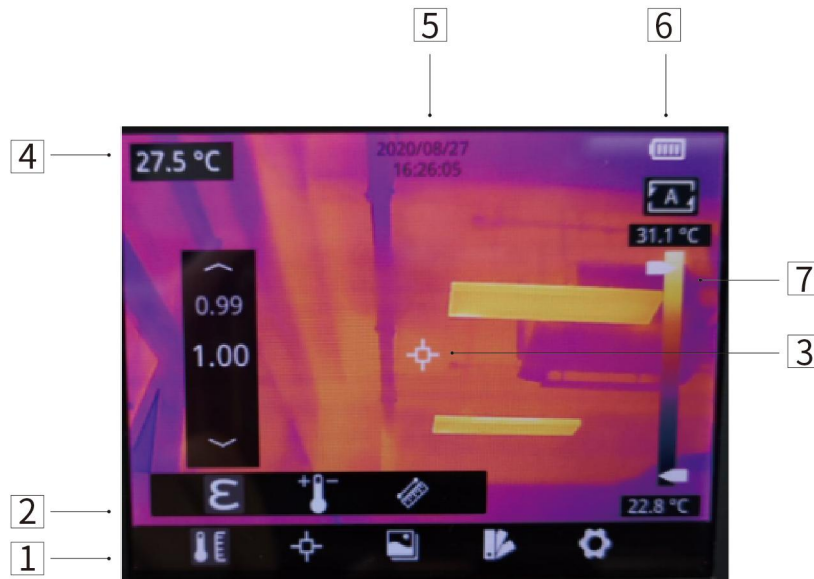

Figure8.4 User Interface

No.	Name	Description
1	Main Menu	parameters, measurement mode, image mode, color palettes and other settings can be set.
2	Sub Menu	specific options can be set, such as a specific color palette.
3	Temperature measurement spot	measurements of center spot, high/low temperature spot tracking, customize spot, customize line, customize area measurement are available.
4	Center spot temperature	the temperature of the center spot is displayed.
5	Date and time	date and time are displayed.
6	Battery capacity	the remaining battery capacity is displayed.
7	Temperature range	the temperature range in the current screen can be displayed.

Table 8.1 Interface Introduction

## 9. Operation Instruction

### 9.1 Charging

#### 9.1.1 Charge with a Power Adapter

1. Plug the power adapter into the socket.
2. Use a USB cable to connect the adapter and the camera to charge.

Note: It takes about 3h to get the device fully charged.

#### 9.1.2 Charge with a Computer

1. Use a USB cable to connect the thermal camera to the computer to charge.

Note: when charging with a computer, the computer should be turned on, and the charging time is longer than using an adapter.

#### 9.1.3 Charge with a Charging Base

1. Connect the power adapter and the charging base with a USB cable, and plug the power adapter into the socket.
2. Take out the battery and place it correctly in the charging base to charge.

Note: When the battery is not placed, the indicator of the charging base flashes; the indicator turns red when the battery is placed and charging; the indicator becomes green when the battery is fully charged.

### 9.2 Power On/Off

1. Press the power button to turn on the device.
2. Press and hold the power button over 3 seconds to turn it off.

### 9.3 Focus Adjustment

Make sure that the device is powered on, align the camera at the measured scene, rotate the focus ring beside the lens clockwise or counterclockwise, which can make the image clearer via focal length adjustment, see the following figure for the detailed adjustment method:

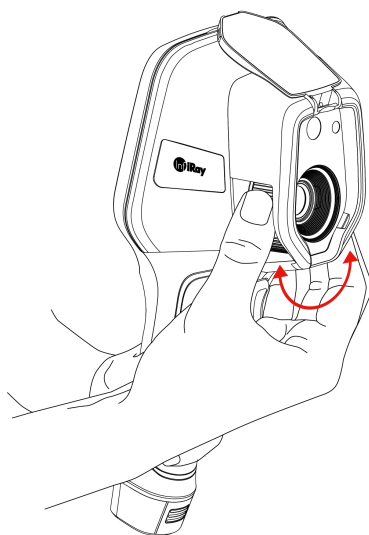

**Figure 9.1 Focus Adjustment Through Focus Ring**

### 9.4 Images/Videos Capture

1. In the observation interface, adjust the focus ring till the image is clear. Short press the trigger button to take the photo. Long press the trigger button to start video recording, and finish recording by releasing and pressing the trigger button again.
2. Tap the save button on the screen or click OK to save the picture. Tap other buttons on the screen or use the navigation button + OK to make recording annotation, scan the QR code to name the file, or cancel saving photos.





## 9.5 View Photos/Videos

The images you captured are saved in the SD card, and you can follow the below steps to view them at any time.

1. Enter the photo gallery by clicking gallery button.
2. Choose the image view modes by clicking the drop-down arrow , there are two kinds of modes: sort by filename or sort by time.

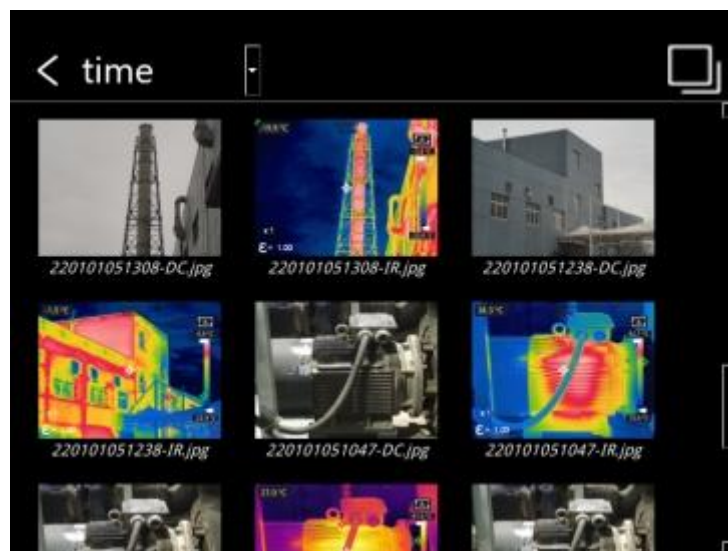

3. Select the picture or video you want to view by pressing the navigation button or touch screen.
4. Press OK or click the picture or video to view it in full screen. Select the delete option and then confirm to delete the current item. Select the rename option and confirm to rename the current item.

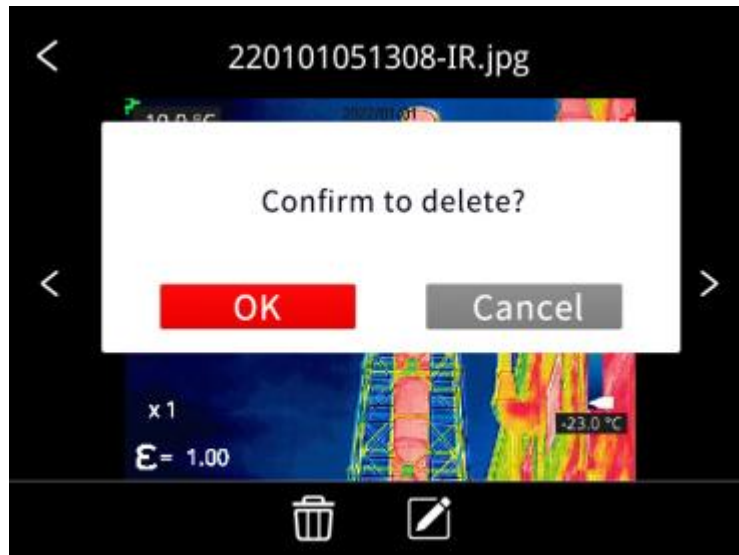

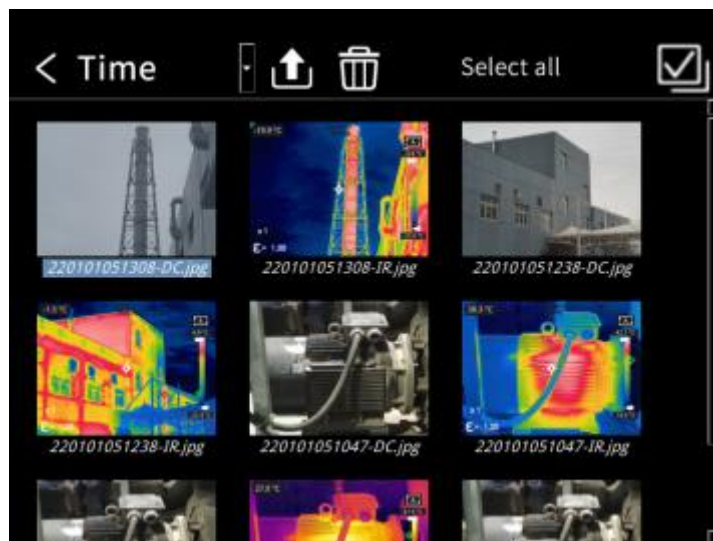

5. In the preview interface, click the multiple button  in the upper right corner of the screen, then select the picture or video to be deleted, and delete the selected items by pressing the delete button.



6. Return to observation interface by clicking the gallery button, back button or touching the screen.

## 9.6 Measurement Mode

In the observation interface, press OK to enter the main menu, and select "Measurement Settings"  with the navigation button. Press OK again to enter the secondary menu, select different measurement modes by navigating left or right by the navigation button, and press OK to save your option.

In the observation interface, click anywhere on the screen to enter the main menu. Then click "Measurement Settings"  to select the desired measurement mode, and make it effective by clicking the screen area.



## 9.7 Measurement Parameters

In the observation interface, press OK to enter the main menu, select the "parameter setting" 

by the navigation button, then press OK again to enter the secondary menu. Select different temperature measurement parameters by navigating left or right, and press the enter button to set, and press OK again to save your option.

In the observation interface, click anywhere on the screen to enter the main menu. Click "Parameter Setting"  to set the related parameters, and click the screen area to take effect.

**Emissivity** : in order to obtain more accurate measurement results, you need to set the emissivity according to the target to be measured before each measurement, instead of using the default configuration. Emissivity refers to the ratio of the radiant ability of an object to the radiant ability of a blackbody at the same temperature, which is relative to the reflectivity of the object. The lower the emissivity, the higher the proportion of energy being reflected. The higher the emissivity, the lower the proportion of energy being reflected. For example, the emissivity of human skin is 0.98, and the emissivity of printed circuit boards is 0.91. For more information on emissivity, you can refer to the quick start guide in the package or inquire from other sources.

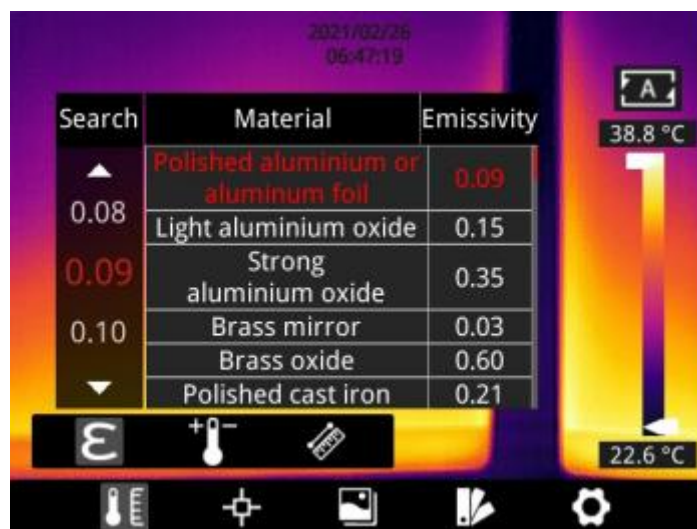

**Ambient temperature**  : the reflection temperature of the object surface will affect the measurement result, especially when the object emissivity is low or the object temperature and the reflection temperature differ greatly, this effect will increase. So the result needs to be compensated to eliminate influences of the surface reflection temperature. However, it is usually difficult to determine the reflected temperature of an object. The ambient temperature can be used to replace the reflected temperature in actual measurement.



**Distance** : distances will influence the measurement results. In order to get accurate measurement, distance information of the object is necessary for the thermal camera to compensate the result.

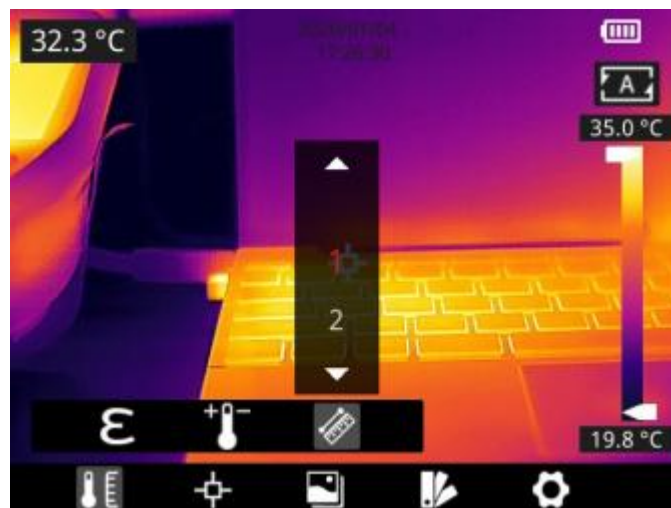

## 9.8 Palettes

In the observation interface, short press OK to enter the main menu, and select "palette setting"  with the navigation button. Press OK again to enter the sub menu, select different palettes by navigating left and right on the navigation button, and then press the enter button to save your option.

In the observation interface, click anywhere on the touch screen to enter the main menu. Click "palette setting"  to choose a palette and save your option by clicking the screen area.

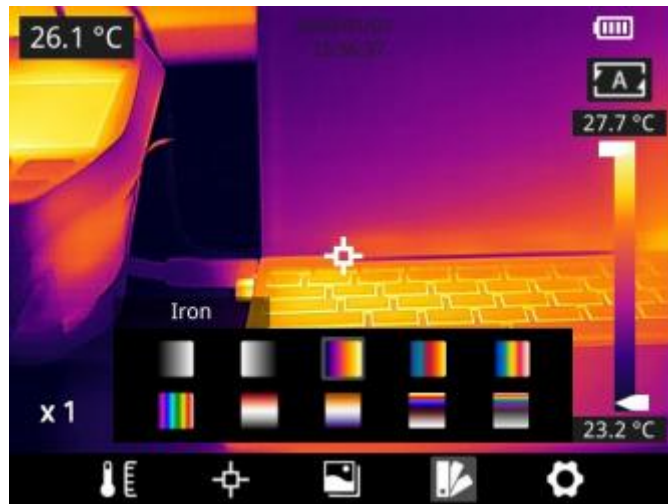

## 9.9 Image Mode

### 9.9.1 Image Mode Introduction

Four image modes are available.

- Thermal Fusion: an image fused to a certain scale between an infrared image and a visible image



- PIP: infrared image superimposed at the center of the visible image.

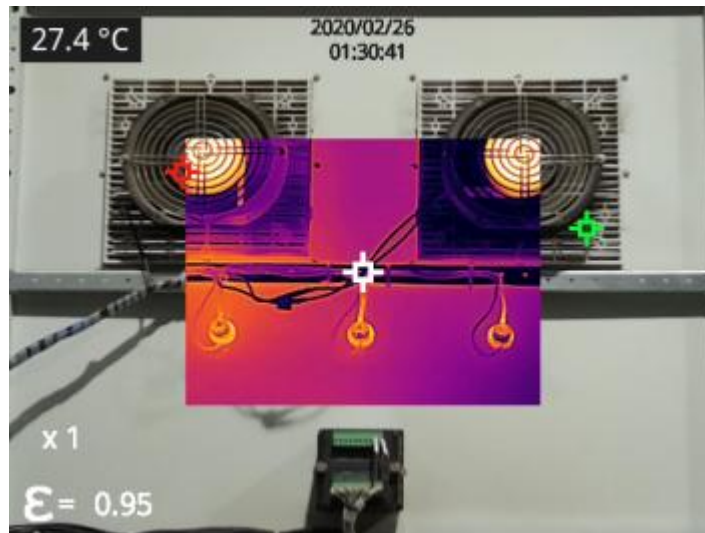

- Thermal imaging: infrared images

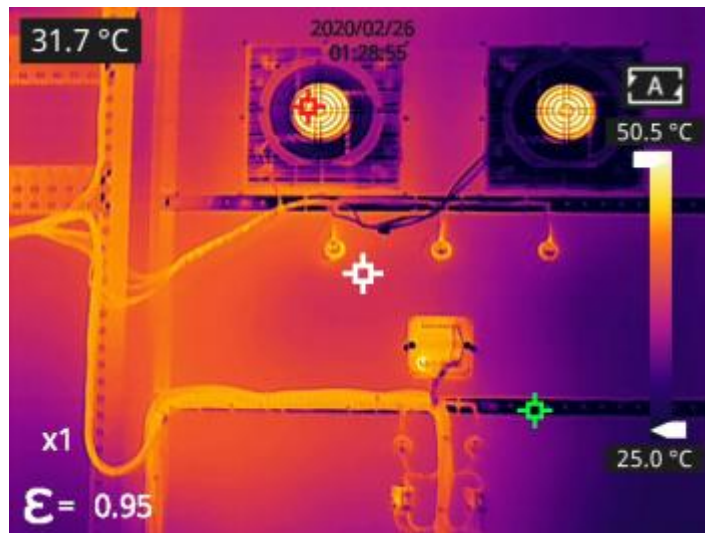



- Digital camera: visible images



Note: For better dual-light image effects, when in PIP or thermal fusion modes, you need to set the actual distance, that is, the approximate distance from the thermal camera to the object. If the preset alignment parameters cannot meet the requirements, you can perform manual fusion alignment in the settings or by dragging on the touch screen.

## 9.9.2 Setting Steps

In the observation interface, press OK to enter the main menu, and select "image mode"  through the navigation button. Then press OK again to enter the secondary menu, different image modes can be selected by navigating leftwards or rightwards. Save your option by pressing Ok button.

In the observation interface, click anywhere on the screen to enter the main menu. Click "image mode"  and select the desired image mode, and then click the screen area to save the option.





## 9.10 Non-uniformity Correction

### 9.10.1 Non-uniformity Correction Introduction

Non-uniformity correction is used to compensate for non-uniformity of detector pixels or non-uniformity caused by other optical interference. When there is more noise in the image, non-uniformity correction is needed, which is common when the ambient temperature changes rapidly.

### 9.10.2 Non-uniformity Correction Operations

In the imaging interface, press and hold the back button  or the gallery button  to perform non-uniformity correction.



## 9.11 Contrast Adjustment

- In the observation interface, the contrast of the infrared image can be adjusted by sliding up and down the arrow button  of the "temperature scale" on the right side of the screen, the upper limit and lower limit of the temperature scale can be set manually.

The default level is 24.2°C-34.6°C in auto mode:

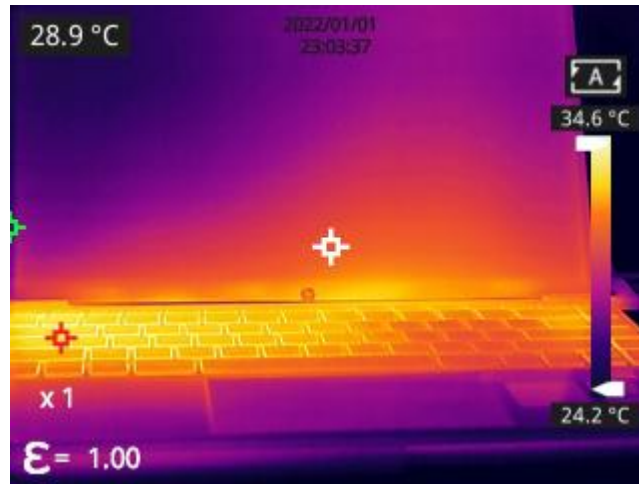

The lower limit of the temperature scale is manually adjusted as 27.7°C:

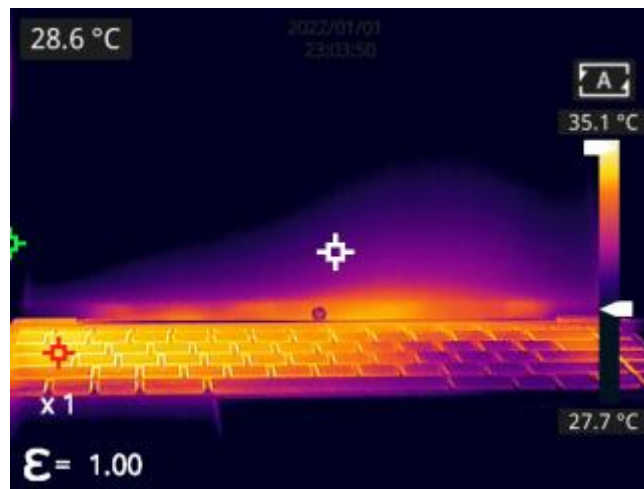

- Press  in the upper right corner of the interface to return to auto-contrast mode. The upper limit and lower limit are auto adjusted according to the Max. temp and Min. temp in the auto mode, the image color is distributed based on the color of the temperature scale.

## 9.12 Digital Zoom

In observation interface, press navigation button to perform Max. 8×digital zoom.

- 1×digital zoom:

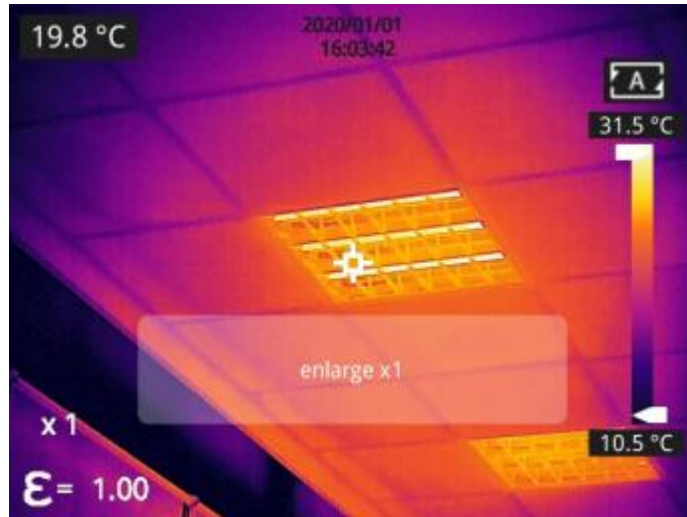

- 2×digital zoom:

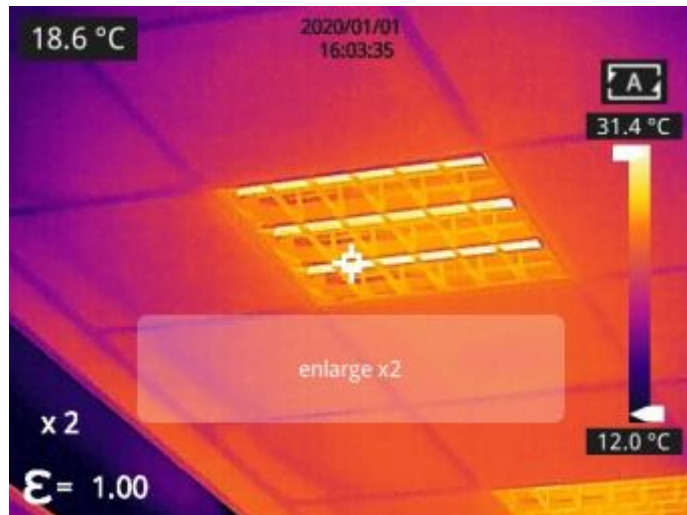

- 4×digital zoom:

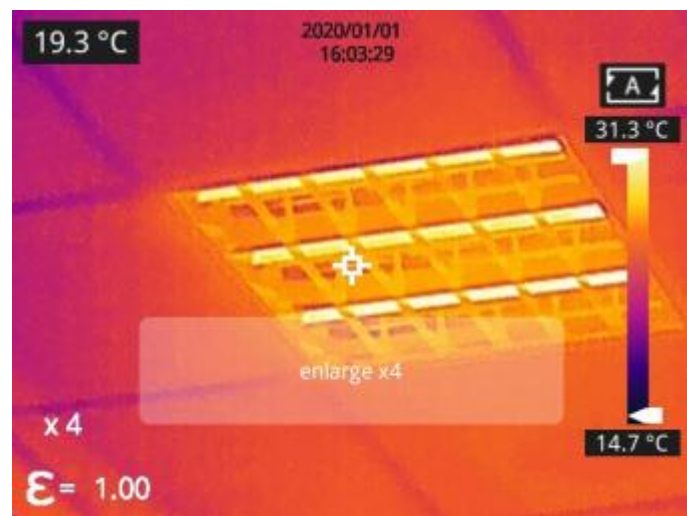

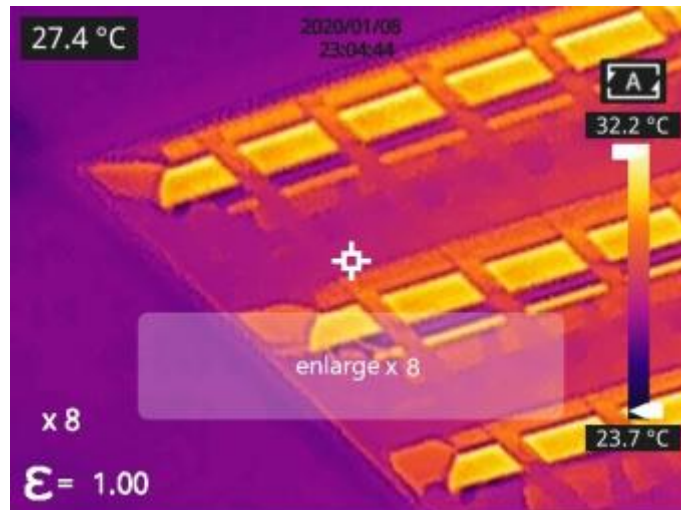

- 8×digital zoom:



**Note:** This function can be enabled in IR mode or Visible mode.

### 9.13 Other Settings

Other settings include date and time, unit and other items.

- 1) In the observation interface, press the OK button to enter the main menu, and select "Settings"  to enter other settings.
- 2) In the observation interface, tap anywhere on the screen to enter the main menu, and tap "Settings"  to enter other settings.

#### 9.13.1 Temperature Measurement Mode

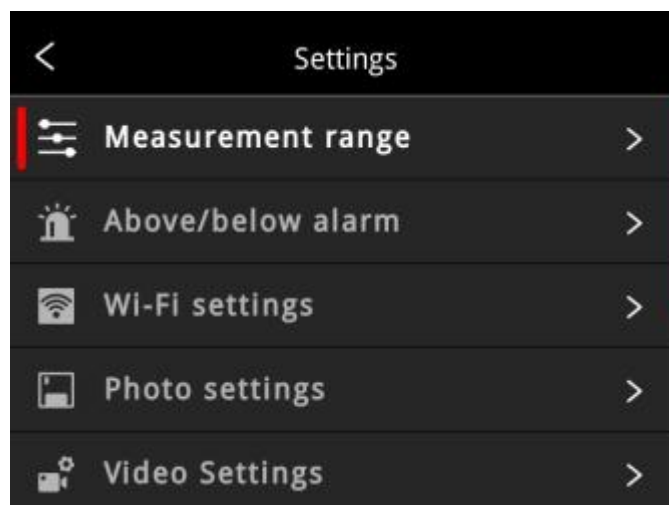

- -20~150°C: the image details are better, and the maximum temperature measured is 150°C.

- 100~550°C: the image details are slightly worse, and the maximum temperature measured is 550°C.

### 9.13.2 Above/Below Alarm

1. Above alarm: click to enable or disable the function of above alarm.

Temperature setting for above alarm: click the pop-up keyboard and set the alarm temperature, 120°C by default.

2. Below alarm: click to enable or disable the function of below alarm.

Temperature setting for below alarm: click the pop-up keyboard and set the alarm temperature, 0°C by default.

- Auto Alarm Snapshot: click to enable or disable, disable by default. Auto capture image during alarm.
- Time Interval: the time interval of alarm snapshot is 10s by default, click to perform custom setup.
- Number of Snapshot: 100 by default, click to perform custom setup.

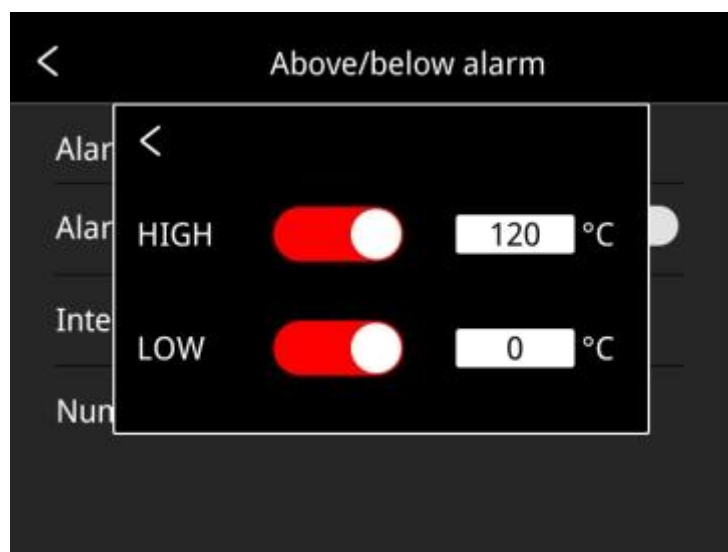
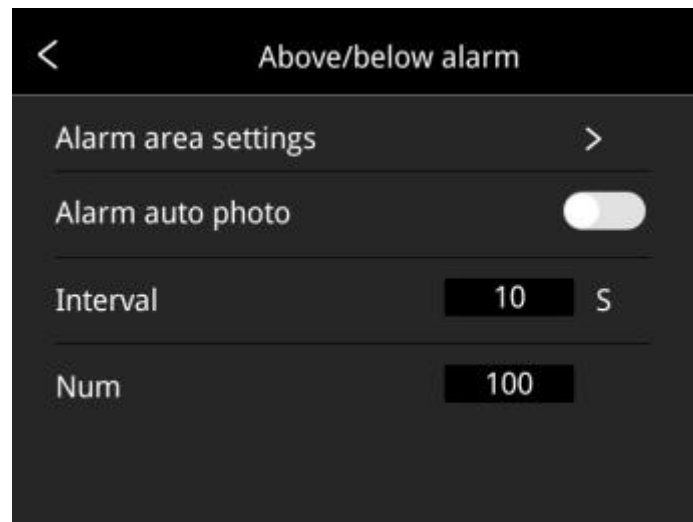

### 9.13.3 Wi-Fi Settings

Click and enter Wi-Fi settings interface.

- Hotspot Switch: turn on hotspot and set the network name and password, then click OK.

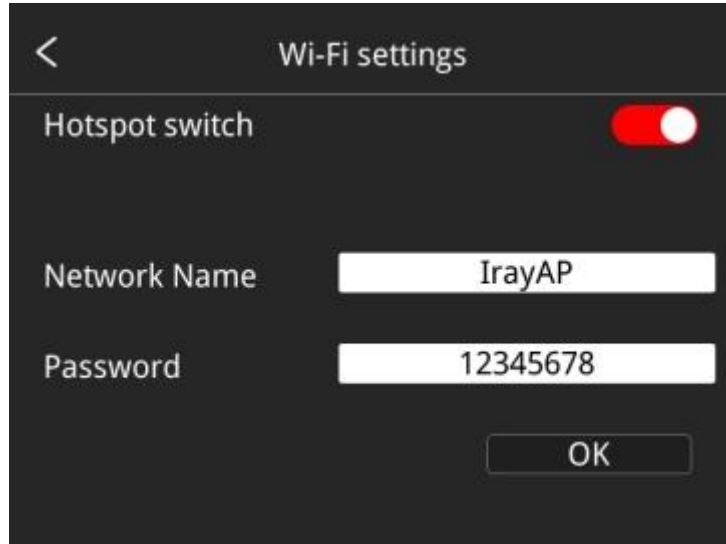

**Note:**

1)The specialized app is needed while this function is enabled. You need connect the hotspot manually after turning hotspot on, and you can transmit the saved pictures or videos to mobile device to perform secondary analysis.

2)Turn off hotspot when it is not used, or else the power consumption will be faster.

### 9.13.4 Photo Settings

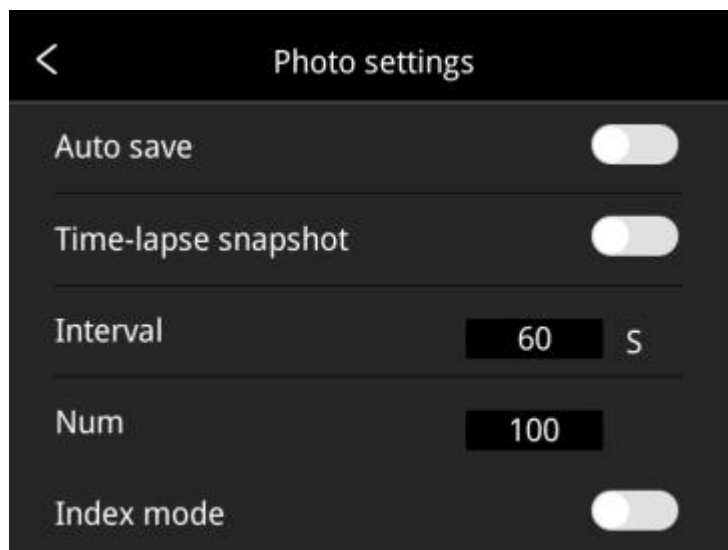

- Auto save of manual snapshot on/off: click to enable or disable the function of auto save of manual snapshot, disabled by default.

- Time-lapse snapshot: click to enable or disable the function of time-lapse snapshot.
- Time interval of time-lapse snapshot: 60s by default, click to perform custom setup.
- Number of time-lapse snapshots: 100 by default, click to perform custom settings.
- Index mode: the file name is Time\_Index\_DC/IR.jpg by default if the index mode is enabled; the file name is Time\_DC/IR.jpg if the index mode is disabled.

### 9.13.5 Dual-spectrum Alignment

- Dual-spectrum Fusion Alignment

This function can be used to manually register infrared and visible images. First select coarse tuning and fine tuning, and then perform image alignment through navigation buttons. After finished, click OK or enter button to save the settings. (You can drag on the touch screen with one finger to achieve fusion alignment in dual-spectrum fusion mode).



- Picture-in-picture Adjustment

This function can be used to adjust the position of the picture-in-picture. First select coarse tuning and fine tuning, and then adjust the position of the picture-in-picture by the navigation buttons. When finished, click OK or enter button to save the settings. (You can move the PIP by dragging the picture with your one finger, and adjust the PIP size by dragging the picture edges).

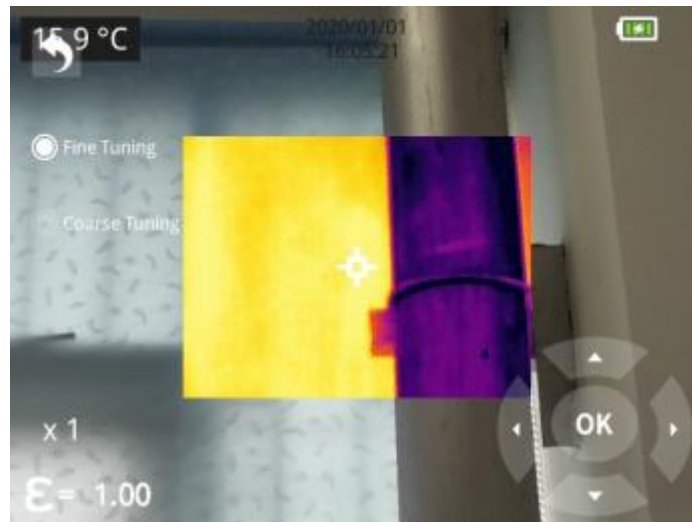

### 9.13.6 Automatic Power-off

- 5Min: click to perform auto shut down after 5 minutes.
- 10Min: click to perform auto shut down after 10 minutes.
- 20Min: click to perform auto shut down after 20 minutes.
- Off: Click to disable the function of auto shutdown, this function is disabled by default.

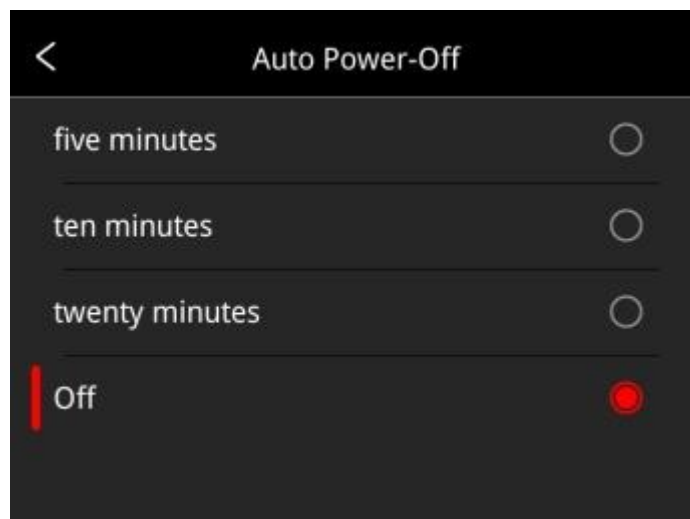

### 9.13.7 System Settings

#### 1. Device Information

Click to check model, version, SD card capacity and SD card remaining capacity.

#### 2. Date & Time

Click to perform date and time settings. The year can be self-defined from the Year 2020 to the Year 2037,

the month, day, hour and min can be changed.

### 3. Unit

(1) Temperature Unit: switch between Celsius, Fahrenheit and Kelvin.

(2) Distance Unit: switch between meter and foot.

### 4. Screen Brightness

Click to perform date and time settings.

- High: click to set the screen brightness as high brightness.
- Medium: click to set the screen brightness as medium brightness, medium brightness by default.
- Low: click to set the screen brightness as low brightness.

### 5. Formatting the SD Card

Click and then press OK to format the SD card as FAT32.

### 6. USB Mode

There are two options for data transmission: U disk and USB camera.

- U disk mode: the saved images and videos can be read and analyzed when the camera is connected with other devices via a data cable in this mode.
- USB camera: the real-time image view and spot/line/region analysis can be achieved on the PC when the camera is connected with the PC via a data cable in this mode.

### 7. Restore Factory Settings

Click and then press OK, the camera will power off automatically a few seconds later, the settings will restore to the factory default state after reboot.

### 8. Software Update

Download the latest software to *Update* file in SD memory, click *Update from SD memory* to update. The camera will power off automatically, the software will update to the latest version after reboot.



## 10. Introduction of Application Scenarios

### 10.1 Detecting of Power Distribution Cabinet

The temperature distribution of power distribution equipment can directly reflect the running status of the equipment. Improper contact or damage may cause abnormal high temperature. The inspection personnel can detect anomalies in time and ensure the safety of power distribution equipment with the aid of M series handheld thermal cameras.

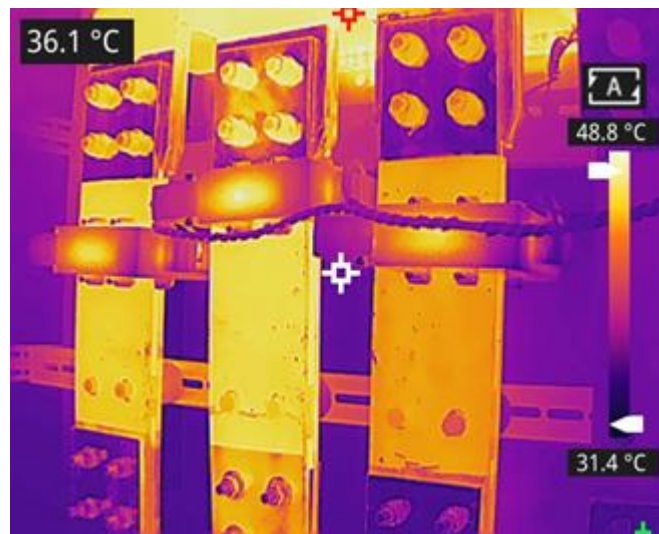

Detecting of Power Distribution Cabinet

## 10.2 Liquid Level Detecting of the Storage Tank

There is a temperature difference between the liquid stored in the tank and the upper gas, which can be transmitted to the tank shell. M series handheld thermal camera can be used to observe the liquid level of the storage tank from a far distance to prevent the accidental failure caused by the failure of the liquid level meter.

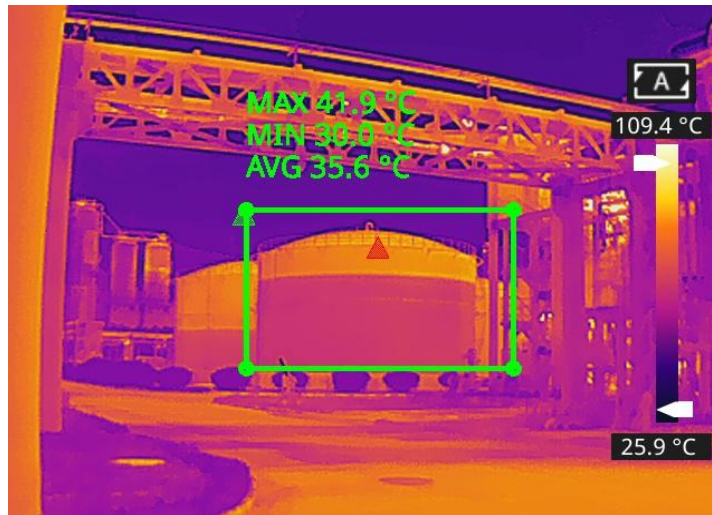

Liquid Level Detecting of the Storage Tank

## 10.3 Circuit Board R&D

The circuit board is small in size, high in integration and complex in structure, so the traditional contact detection consumes lots of time and energy. Infrared thermal imaging technology has absolute advantage in detecting faulty circuit board. M series handheld thermal cameras can be used to quickly find abnormal high or low temperature components and determine circuit board malfunctions.

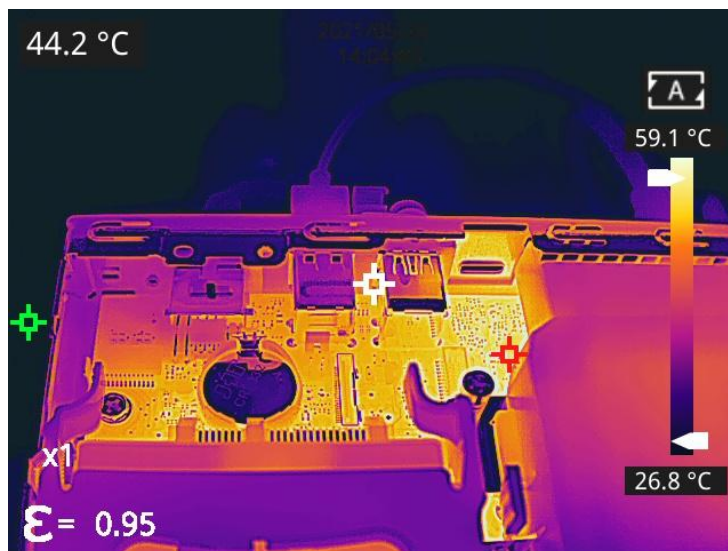

Circuit Board R&D

## 10.4 Defect Detecting of Refractory Material in Rotary Kiln

Rotary kiln is an important equipment for hazardous waste incineration. As the rotary kiln runs for a long time, the lining material may erode and become thin or even fall off, resulting in abnormal external temperature. M series handheld thermal cameras can be used to detect the abnormal high temperature of the outer wall, find and locate the high temperature position, and take corresponding measures to avoid safety accidents.

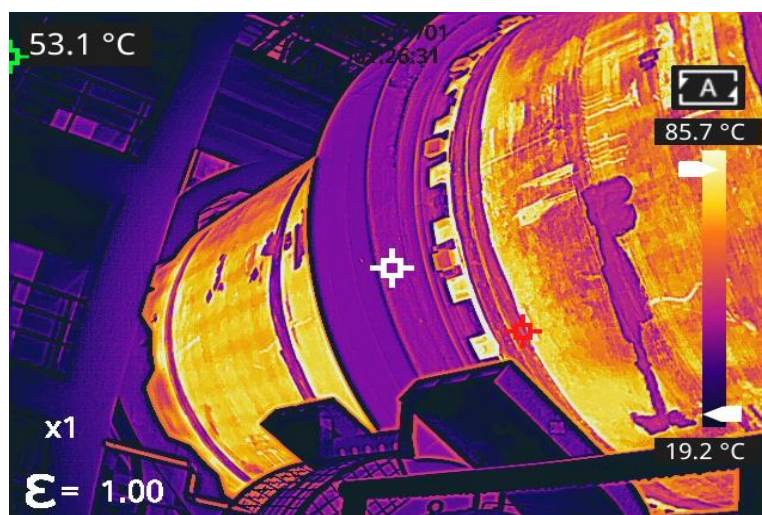

Defect Detecting of Refractory Material in Rotary Kiln

# 11. Structural Drawings

## 11.1 M305

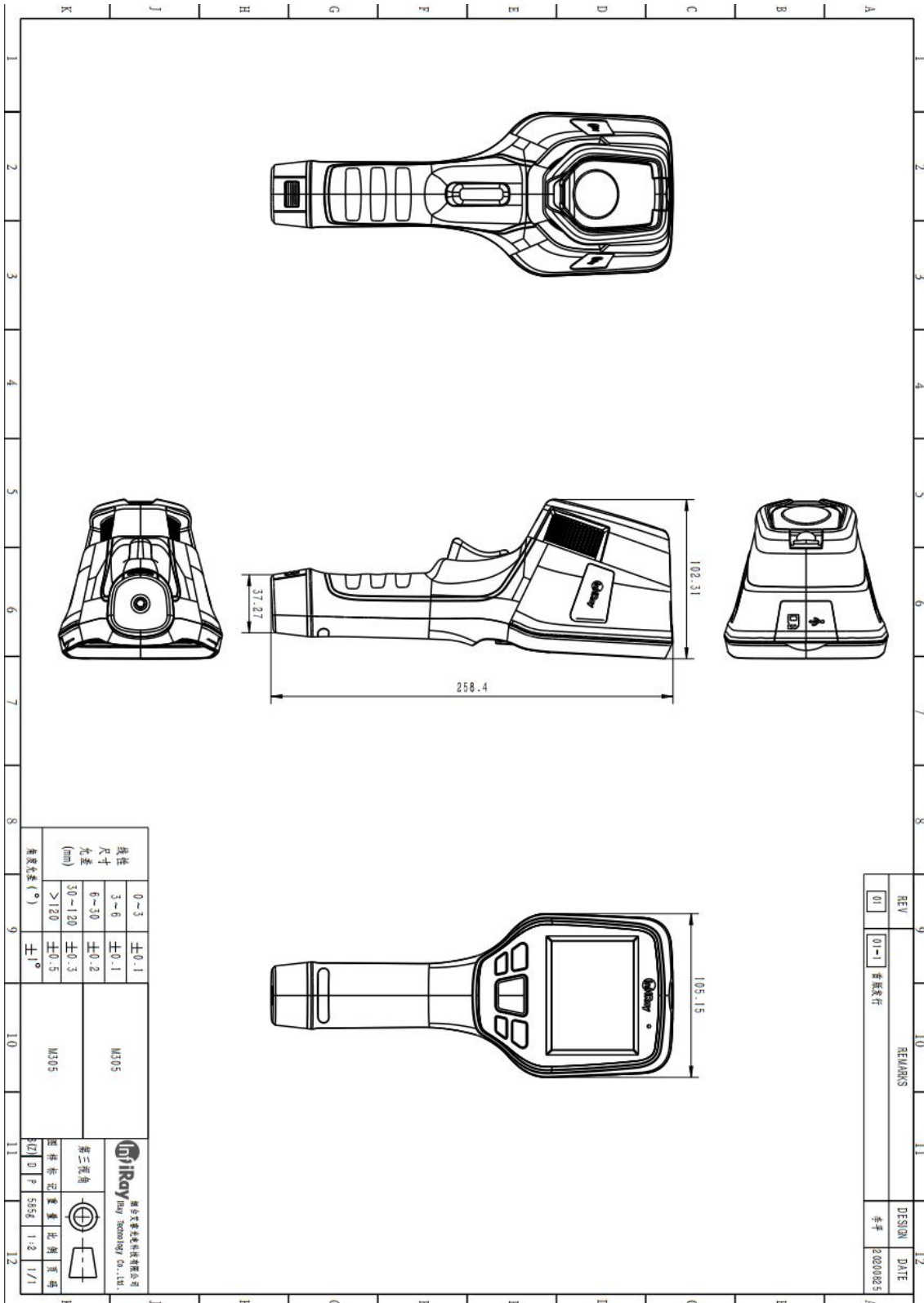

11.2 M600

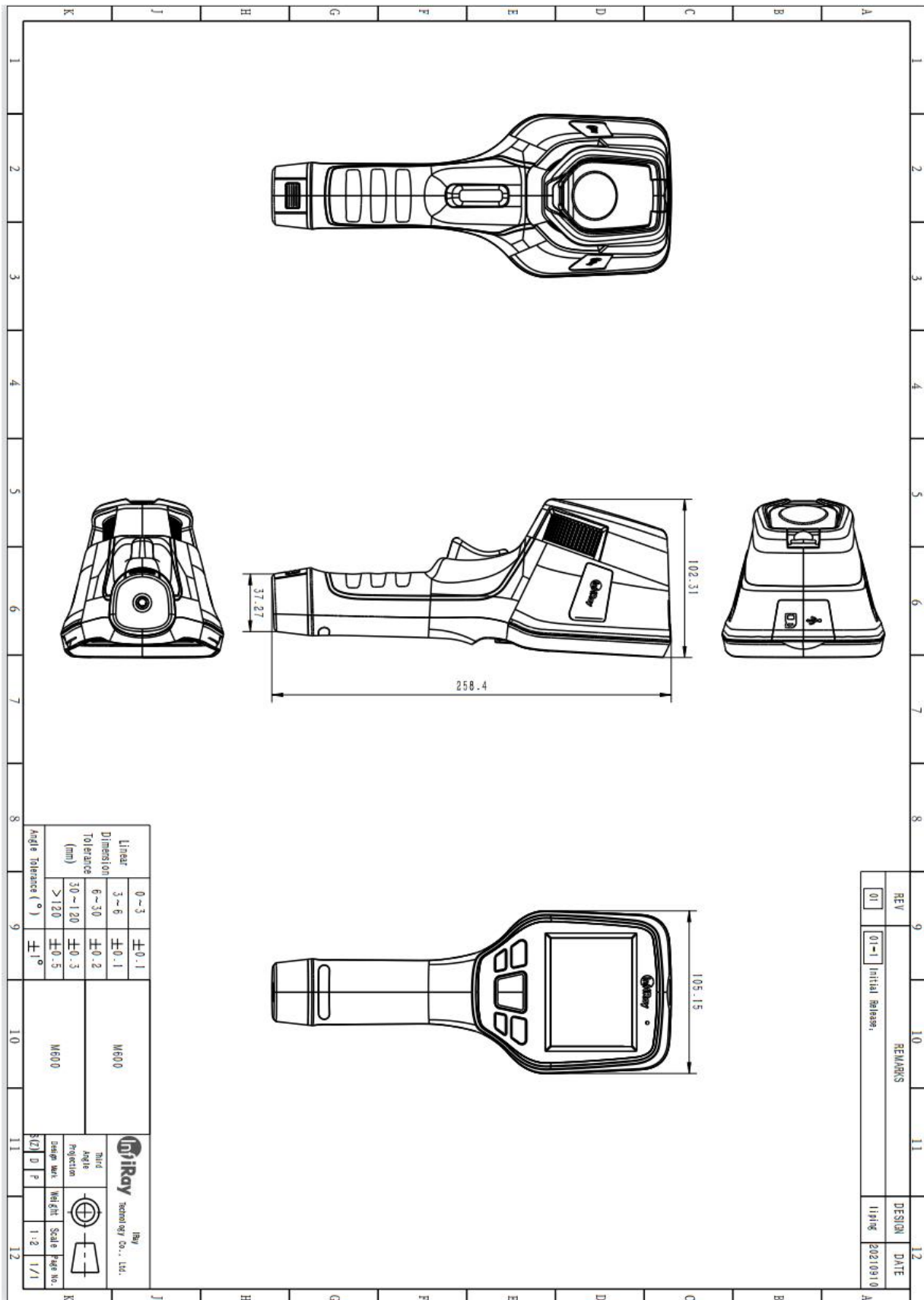

## 12.FAQ

1. The dual-spectrum fusion can not be used properly.

Possible cause: the dual-spectrum fusion has not been adjusted for targets of different distances.

Solution: the dual-spectrum alignment can be adjusted by fine tuning or coarse tuning through the navigation bar.

2. The image is too bright or too dark, highlighting targets within a certain temperature range.

Possible cause: the manual level/span has been enabled.

Solution: click A in the top right corner of the screen to enable auto level/span.

3. The image is too light or too dark and highlights the targets within a certain temperature range.

Possible cause: the manual level/span has been enabled.

Solution: Click A on the top right corner of the screen to achieve auto level/span.

## 13.Download Software and Update Firmware

### 13.1 Download Software

1. Visit our official website: [www.infiray.com](http://www.infiray.com), and enter Service Support-Product Support Center to find M305/M600. Click to enter Client, and you can download M series handheld PC client TAS\_V2.8.0(005)\_WIN64.exe or the Android client android\_irpt\_tas\_V1.4.1\_S\_build\_4.apk

2. Follow the instructions to install TAS\_V2.8.0(005)\_WIN64.exe on a PC or android\_irpt\_tas\_V1.4.1\_S\_build\_4.apk on a mobile phone.

3. After the installation is completed, there is no need to restart the computer or phone, you can preview pictures and videos taken by the device, perform secondary analysis on infrared images and generate test reports.

### 13.2 Update Firmware

If the firmware of the device needs to be updated, please call the technical support hotline 400-883-0800 and update it under the guidance of the product application engineer.

## 14. Cleaning Thermal Camera

### 14.1 Cleaning Camera Housing, Cables and Other Items

Camera Housing, Cables and Other Items	
Liquids	One of the following liquids can be used. 1. Warm water 2. A Weak detergent solution
Cleaning Tools	A soft cloth
Cleaning Procedure	Please follow this procedure: 1. Soak a soft cloth in the liquid. 2. Twist the cloth to remove excess liquid. 3. Clean the camera parts with the cloth.



#### CAUTION

Do not apply solvents or similar liquids to the camera, the cables, or other items. This can cause damage.

## 14.2 Cleaning Infrared Lens

Cleaning Infrared Lens	
Liquids	One of the following liquids can be used. Commercial lens cleaning liquid with more than 30% is isopropyl alcohol. 2. 96% ethyl alcohol(C <sub>2</sub> H <sub>5</sub> OH).
Cleaning Tools	cotton wool
Cleaning Procedure	Please follow this procedure: 1. Soak the cotton wool in the liquid. 2. Twist the cotton wool to remove the excess liquid. 3. Clean the lens one time only and discard the cotton wool.



### CAUTION

Do not clean the infrared lens too vigorously. This can damage the anti-reflective coating.



## Worth comes from Service

---

---

**24h Hotline:**

**400-998-3088**

---

**Technical Support**

**Hotline:**

**400-883-0800**

---

**Customized Services**